



ECO-300

WALL AND CEILING PANEL SYSTEMS



RESIDENTIAL • COMMERCIAL • CLEANROOM

Supplied and Designed By: Johnson Building Systems, Inc.
975 Jaymor Rd. - Southampton, PA 18966-3854
Tel: 800-445-7249 or (215) 673-6050 Fax: (215) 322-2076
Member: www.JohnsonEnergyGroup.com



ECO-300 WALL PANEL SYSTEMS

ECONOMICAL AND ECO-FRIENDLY

3" ECO-300 WALL, CEILING AND ROOF PANELS

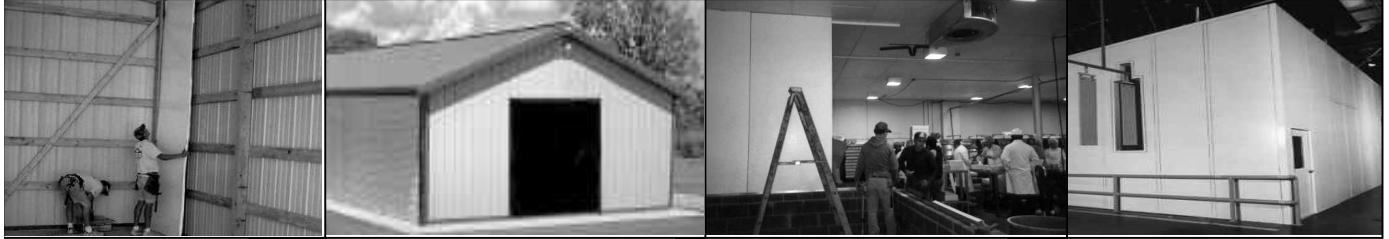







PANEL DESIGN

INSOLRAE ECO-300 incorporates a tongue and groove joint design of 3" EPS 1# Density Solid Core insulation.

The Aesthetically Pleasing "SHADOW LINE" smooth face profile lightly accents and stiffens the galvalume sheets with a 3/32" deep, vertical straight groove pattern, painted with a USDA siliconized polyester chemical resistant finish.

INSOLRAE ECO-300R 3" Rigid-R-Board a thermal reflective self taping system consisting of a clean textured white reinforce foil scrim on exposed side and aluminum reflective foil back side of 3" EPS Solid Core Insulation 1# density.

Prod.No	Description	R-Value	Net / Sq.Ft.
ECO-300	.019 White Galvalume	R-13.5	\$4.95
ECO-300R	Rigid-R-Board with Reflective Foil	R-18	\$1.95

Prod.No	Description	EA. 8'	EA. 10'
V-121	 PVC 1-1/2" X 1-1/2" INSIDE CORNER ANGLE	\$4.50	\$5.35
V-123	 PVC 1-1/2" X 1-1/2" OUTSIDE CORNER ANGLE	\$4.50	\$5.35
G-315	 GALVANIZED WHITE 26 GA FLOOR CHANNEL	\$13.15	\$16.40
PVE-345	 PVC 3" LEDGE CAP (1" LEGS)	\$10.25	\$12.50
PVE-325	 PVC 3" CAP (1" LEGS)	\$8.55	\$10.90
PVE-310*	 PVC 3" FLOOR SCREED (1-5/8" LEGS)	\$11.25	-

Color Selection: * White or Gray

CONSTRUCTION DETAILS:

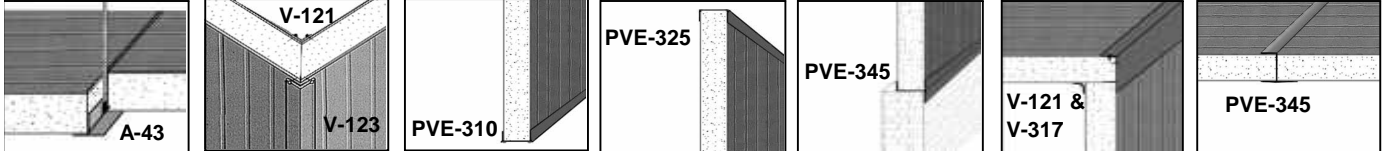

Accessible Suspended Ceiling System

The INSOLRAE Aluminum Ceiling System is excellent for all indoor industrial ceilings, presenting a structural system has a cleaner appearance supporting larger size panels and surface mounted lighting accessible with a clean white powder coated finish.

For extra heavy duty corrosion resistant applications use V-41, V-42 & V-43 Special PVC Covers.



Actual 23 5/8" x 47 5/8"

FVT Vapor Tite-Flourescent CR-131-Flush Flourescent

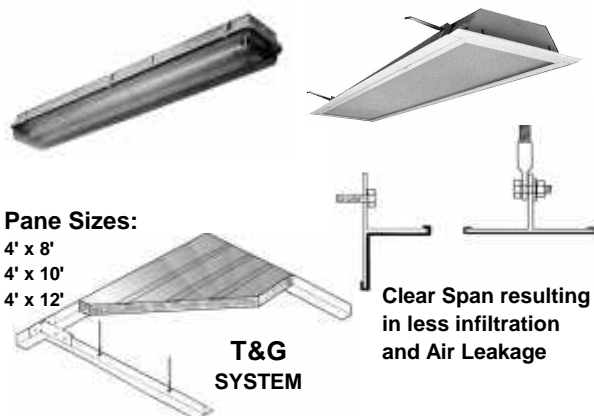









Pane Sizes:

- 4' x 8'
- 4' x 10'
- 4' x 12'

T&G SYSTEM

Clear Span resulting in less infiltration and Air Leakage

Product #	Description	Length FT	Size W x H
A-43	4" Main Tee (Max 20')	16	4" x 2"
A-45	3" Wall Angle 120°	16	3" x 3"
A-46	3" Wall Angle 90° (Max 20')	16	3" x 3"
PV-5010	PVC Wall Clip (Pre-Drilled)		
PV-5020	PVC Splice Clip		
PVC CORROSION RESISTANT COVERS			
V-43	4"x8' FLAT T-BAR		
V-42	2"x2"x8' T-BAR INSIDE CORNER		
V-41	2"x2"x8' OUTSIDE CORNER		
3/8" ZINC PLATED CEILING HARDWARE			
2200	C-Clamps-Zinc Plated		
4400-HD	Eye-Coupling w/nut&bolt		
1880	6' Redi Rod		
4420	Redi Rod Connector		

100080-V714	Norton Gray Gasket Field Applied 1/8"x1/2"x100'	
-------------	--	---